

FORMBASE FURNITURE 2024

STAGING SYSTEMS



The Ultralight staging system is versatile and easy to use. The expanding aluminium base and lightweight staging platform are designed to be quickly and easily assembled by one person. The tubular base opens and closes in seconds and the placement of platforms is quick and simple. Although the individual components are extremely lightweight, together they form an incredibly strong staging unit, which supports a uniformly distributed load of 1000kg per square metre. Base units fold to less than 2% of their open size and stage decks have a depth of only 30mm making them easy to transport and store.

The decks and risers come in a range of heights and finishes and there is a range of accessories including a stage valance, side and back rails and a trolley. We have assembled some of the most popular configurations into handy packs or you can contact us for a bespoke staging systems quote.

1



Take your folded stage riser.

2



Fully extend the stage riser.

3



Place the stage deck on top of the riser, connecting each corner of the stage deck with the upright corner bolts on the riser.

Once the corner sections have been connected, tighten with the Allen Key through the small hole in each corner of the stage deck. Alternatively twist the stage riser tube.

4



5



Having joined your stage decks and risers together, connect each platform by tightening the locking cleats located on the leading edge of each stage deck.

6



If required, you can join two risers together for additional height and they will still fold down without having to be separated.

7



The stage decks and risers take up minimal space, making this system the ideal choice for those with limited storage.

5 Rectangular Staging

Ultralight staging system components are made up from risers and decks. The risers come in a choice of 5 heights and the decks in a choice of carpet, vinyl or heavy duty vinyl.

CODE	DESCRIPTION	SIZE IN MM	WEIGHT	PRICE
S24SS09001	Rectangular Riser	1000L x 520W	1.5-3kg	£90.25
S24SS09002	Carpetted Deck	1000L x 520W	4.5kg	£169.35
S24SS09003	Vinyl Deck	1000L x 520W	5kg	£177.70
S24SS09004	Heavy Duty Vinyl Deck	1000L x 520W	7.5kg	£189.75

- Tested to 1000kg per metre squared even load
- Point load testing to 180kg
- Accessories available on pages 158 - 159



Carpet colours:



Vinyl:



HD Vinyl:



Riser Heights:
150mm, 200mm, 300mm, 400mm, 600mm

5 Rectangular Staging

Ultralight staging system components are made up from risers and decks. The risers come in a choice of 5 heights and the decks in a choice of carpet, vinyl or heavy duty vinyl.

CODE	DESCRIPTION	SIZE IN MM	WEIGHT	PRICE
S24SS09005	Rectangular Riser	2000L x 520W	2-3kg	£138.80
S24SS09006	Carpetted Deck	2000L x 520W	9.5kg	£219.25
S24SS09007	Vinyl Deck	2000L x 520W	10.5kg	£228.95
S24SS09008	Heavy Duty Vinyl Deck	2000L x 520W	14kg	£246.45

- Tested to 1000kg per metre squared even load
- Point load testing to 180kg
- Accessories available on pages 158 - 159



Carpet colours:

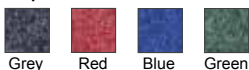

Vinyl:



HD Vinyl:



Riser Heights:
150mm, 200mm, 300mm, 400mm, 600mm

5 Rectangular Staging

Ultralight staging system components are made up from risers and decks. The risers come in a choice of 5 heights and the decks in a choice of carpet, vinyl or heavy duty vinyl.

CODE	DESCRIPTION	SIZE IN MM	WEIGHT	PRICE
S24SS09009	Rectangular Riser	2000L x 1000W	4-7kg	£242.90
S24SS09010	Carpetted Deck	2000L x 1000W	12.75kg	£330.30
S24SS09011	Vinyl Deck	2000L x 1000W	14kg	£348.40
S24SS09012	Heavy Duty Vinyl Deck	2000L x 1000W	17kg	£381.90

- Tested to 1000kg per metre squared even load
- Point load testing to 180kg
- Accessories available on pages 158 - 159



Carpet colours:

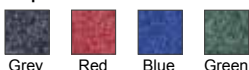

Vinyl:



HD Vinyl:



Riser Heights:
150mm, 200mm, 300mm, 400mm, 600mm

5 Square Staging



Riser Heights:
150mm, 200mm, 300mm, 400mm, 600mm

Ultralight staging system components are made up from risers and decks. The risers come in a choice of 5 heights and the decks in a choice of carpet, vinyl or heavy duty vinyl.

CODE	DESCRIPTION	SIZE IN MM	WEIGHT	PRICE
S24SS09013	Square Riser	520L x 520W	1-2kg	£76.35
S24SS09014	Carpetted Deck	520L x 520W	2.5kg	£131.85
S24SS09015	Vinyl Deck	520L x 520W	3.5kg	£141.55
S24SS09016	Heavy Duty Vinyl Deck	520L x 520W	5kg	£150.40

- Tested to 1000kg per metre squared even load
- Point load testing to 180kg
- Accessories available on pages 158 - 159



Carpet colours:

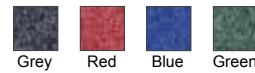

Vinyl:



HD Vinyl:



5 Square Staging

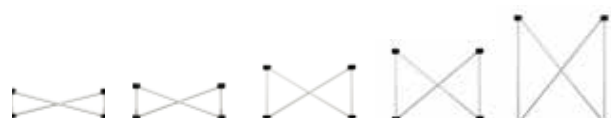

Riser Heights:
150mm, 200mm, 300mm, 400mm, 600mm

Ultralight staging system components are made up from risers and decks. The risers come in a choice of 5 heights and the decks in a choice of carpet, vinyl or heavy duty vinyl.

CODE	DESCRIPTION	SIZE IN MM	WEIGHT	PRICE
S24SS09017	Square Riser	1000L x 1000W	2-4kg	£138.80
S24SS09018	Carpetted Deck	1000L x 1000W	7.5kg	£219.25
S24SS09019	Vinyl Deck	1000L x 1000W	8.5kg	£228.95
S24SS09020	Heavy Duty Vinyl Deck	1000L x 1000W	12kg	£249.95

- Tested to 1000kg per metre squared even load
- Point load testing to 180kg
- Risers can be doubled up as shown
- Accessories available on pages 158 - 159



Carpet colours:

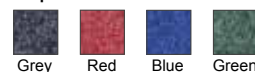

Vinyl:



HD Vinyl:



5 Quadrant Staging

Ultralight staging system components are made up from risers and decks. The risers come in a choice of 5 heights and the decks in a choice of carpet, vinyl or heavy duty vinyl.

CODE	DESCRIPTION	SIZE IN MM	WEIGHT	PRICE
S24SS09021	Quadrant Riser	1000W x 1000W x 1306L	1-2kg	£109.60
S24SS09022	Carpetted Deck	1000W x 1000W x 1306L	4kg	£219.20
S24SS09023	Vinyl Deck	1000W x 1000W x 1306L	5kg	£228.20
S24SS09024	Heavy Duty Vinyl Deck	1000W x 1000W x 1306L	7kg	£244.15

- Tested to 1000kg per metre squared even load
- Point load testing to 180kg
- Accessories available on pages 158 - 159



Carpet colours:

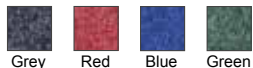

Vinyl:



HD Vinyl:



Riser Heights:
150mm, 200mm, 300mm, 400mm, 600mm

5 Triangle Staging

Ultralight staging system components are made up from risers and decks. The risers come in a choice of 5 heights and the decks in a choice of carpet, vinyl or heavy duty vinyl.

CODE	DESCRIPTION	SIZE IN MM	WEIGHT	PRICE
S24SS09025	Triangle Riser	100W x 1000W x 1591L	1-2kg	£108.25
S24SS09026	Carpetted Deck	100W x 1000W x 1591L	4kg	£201.20
S24SS09027	Vinyl Deck	100W x 1000W x 1591L	5kg	£209.55
S24SS09028	Heavy Duty Vinyl Deck	100W x 1000W x 1591L	7kg	£224.50

- Tested to 1000kg per metre squared even load
- Point load testing to 180kg
- Accessories available on pages 158 - 159



Carpet colours:

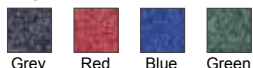

Vinyl:



HD Vinyl:



Riser Heights:
150mm, 200mm, 300mm, 400mm, 600mm

5 Staging Package A



This Ultralight package is 430mm high and covers 8M². Choose from carpetted, vinyl or heavy duty vinyl decks.

The package includes:

- 4 x Stage decks and risers 2M x 1M (430mm high)
- 1 x Stage Step deck and riser 1M x 0.52M (230mm high)
- 2 x Riser clamps

CODE	DESCRIPTION	HEIGHT	SIZE IN MM	PRICE
S24SS09029	Carpetted Decks	430mm	2000W x 4000L	£2559.00
S24SS09030	Vinyl Decks	430mm	2000W x 4000L	£2630.40
S24SS09031	Heavy Duty Vinyl Decks	430mm	2000W x 4000L	£2784.90
S24SS09032	Valance for Package A			£520.75

- Tested to 1000kg per metre squared even load
- Point load testing to 180kg
- All packages are supplied with a 5mm Allen key
- Accessories available on pages 10-12

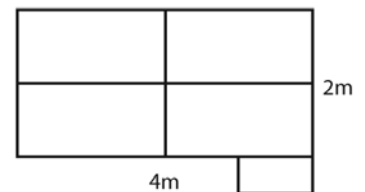
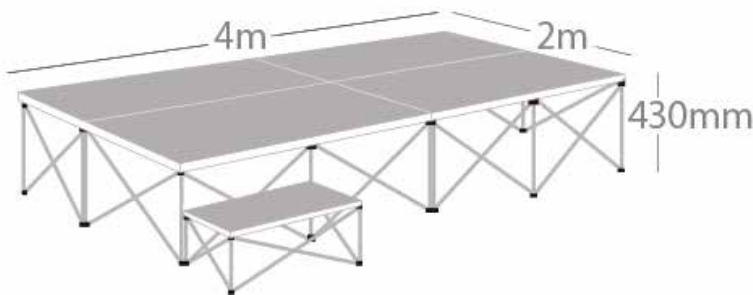

Carpet colours:



Vinyl:



HD Vinyl:



Valance colours:



5 Staging Package B



This Ultralight package is 430mm high and covers 12M². Choose from carpetted, vinyl or heavy duty vinyl decks.

The package includes:

- 6 x Stage decks and risers 2M x 1M (430mm high)
- 1 x Stage Step deck and riser 1M x 0.52M (230mm high)
- 2 x Riser clamps

CODE	DESCRIPTION	HEIGHT	SIZE IN MM	PRICE
S24SS09033	Carpetted Decks	430mm	3000W x 4000L	£3705.85
S24SS09034	Vinyl Decks	430mm	3000W x 4000L	£3812.25
S24SS09035	Heavy Duty Vinyl Decks	430mm	3000W x 4000L	£4032.05
S24SS09036	Valance for Package B			£675.75

- Tested to 1000kg per metre squared even load
- Point load testing to 180kg
- All packages are supplied with a 5mm Allen key
- Accessories available on pages 10-12

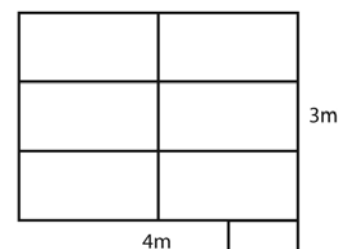
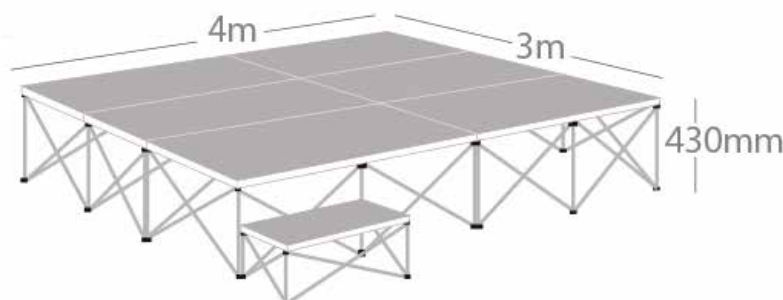

Carpet colours:



Vinyl:



HD Vinyl:



Valance colours:



5 Staging Package C

This Ultralight package is 630mm high and covers 15M². Choose from carpetted, vinyl or heavy duty vinyl decks.

The package includes:

- 6 x Stage decks and risers 2M x 1M (630mm high)
- 3 x Stage decks and risers 1M x 1M (630mm high)
- 1 x Stage Step deck and riser 1M x 0.52M (430mm high)
- 1 x Stage Step deck and riser 1M x 0.52M (230mm high)
- 4 x Riser clamps

CODE	DESCRIPTION	HEIGHT	SIZE IN MM	PRICE
S24SS09037	Carpetted Decks	630mm	3000W x 5000L	£5044.20
S24SS09038	Vinyl Decks	630mm	3000W x 5000L	£5183.15
S24SS09039	Heavy Duty Vinyl Decks	630mm	3000W x 5000L	£5484.95
S24SS09040	Valance for Package C			£1019.20

- Tested to 1000kg per metre squared even load
- Point load testing to 180kg
- All packages are supplied with a 5mm Allen key
- Accessories available on pages 10-12

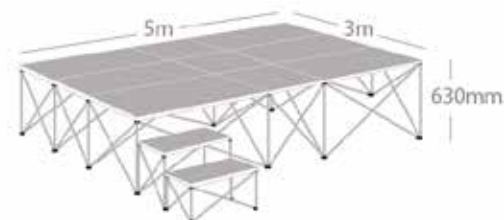
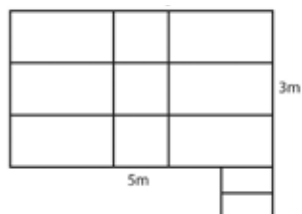

Carpet colours:

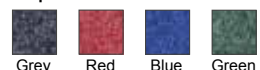

Vinyl:



HD Vinyl:



Valance colours:



5 Staging Package D

This Ultralight package is 630mm high and covers 18M². Choose from carpetted, vinyl or heavy duty vinyl decks.

The package includes:

- 9 x Stage decks and risers 2M x 1M (630mm high)
- 1 x Stage Step deck and riser 1M x 0.52M (430mm high)
- 1 x Stage Step deck and riser 1M x 0.52M (230mm high)
- 4 x Riser clamps

CODE	DESCRIPTION	HEIGHT	SIZE IN MM	PRICE
S24SS09041	Carpetted Decks	630mm	3000W x 6000L	£5690.20
S24SS09042	Vinyl Decks	630mm	3000W x 6000L	£5852.95
S24SS09043	Heavy Duty Vinyl Decks	630mm	3000W x 6000L	£6183.40
S24SS09044	Valance for Package D			£1093.60

- Tested to 1000kg per metre squared even load
- Point load testing to 180kg
- All packages are supplied with a 5mm Allen key
- Accessories available on pages 10-12

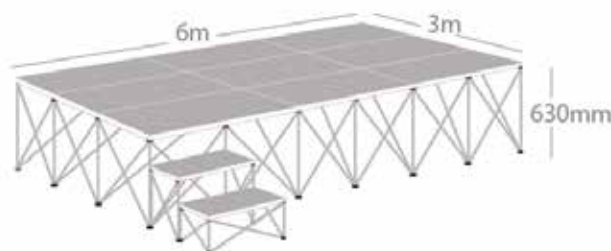
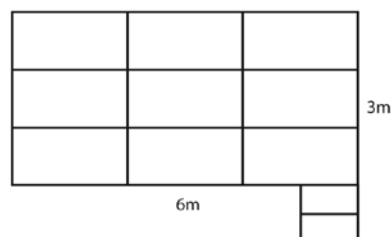

Carpet colours:

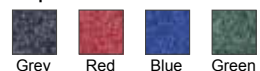

Vinyl:



HD Vinyl:



Valance colours:



Our specially designed choir staging enables choirs of all sizes to perform and be seen by their audience. These infill units can be used alongside the square and rectangular units to create a curve.

It is lightweight, folding and easy to assemble and disassemble. It can easily be transported from venue to venue and comes with a choice of carpetted, vinyl or heavy duty vinyl decks.

We have put together three packages to suit various choir configurations and hall spaces.

Optional accessories including valances, safety guardrails and chair stop plates can be found on pages 148 - 149.



5 Choir Package 1

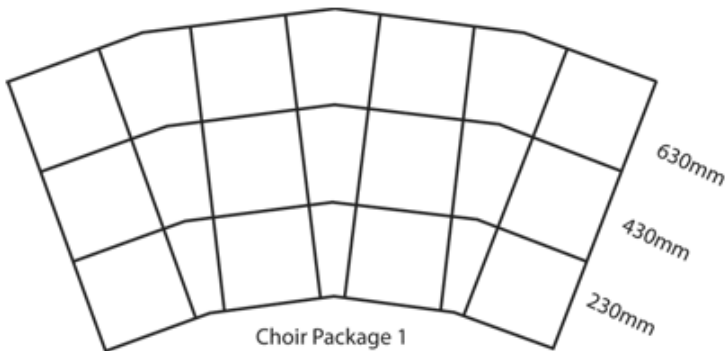

This Ultralight choir package has a clever concertina design and is lightweight yet extremely strong. Choose from carpetted, vinyl or heavy duty vinyl decks.

The package includes:

12 x Stage decks & risers 1M x 1M (4 x 230H, 4 x 430H, 4 x 630H)

9 x Choir infill decks and risers 1M (3 x 230H, 3 x 430H, 3 x 630H)

28 x Riser clamps

CODE	DESCRIPTION	SIZE IN MM	PRICE
S24SS09045	Carpetted Decks	1000L x 1000W	£5976.90
S24SS09046	Vinyl Decks	1000L x 1000W	£6309.90
S24SS09047	Heavy Duty Vinyl Decks	1000L x 1000W	£6763.30

- Tested to 1000kg per metre squared even load
- Point load testing to 180kg
- A 5mm Allen key is supplied for assembly

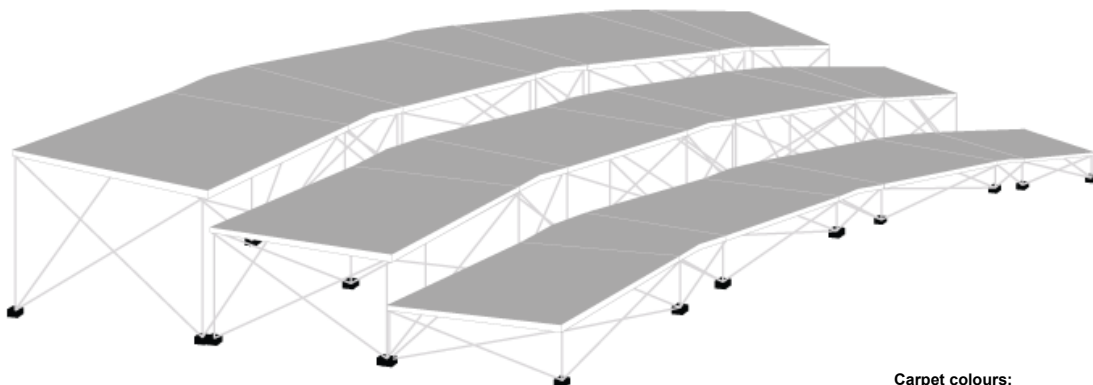

Carpet colours:

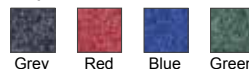

Vinyl:



HD Vinyl:



5 Choir Package 2

This Ultralight choir package has a clever concertina design and is lightweight yet extremely strong. Choose from carpetted, vinyl or heavy duty vinyl decks.

The package includes:

- 12 x Stage decks & risers 1M x 0.52M (4 x 230H, 4 x 430H, 4 x 630H)
- 9 x Choir infill decks and risers 0.52M (3 x 230H, 3 x 430H, 3 x 630H)
- 28 x Riser clamps

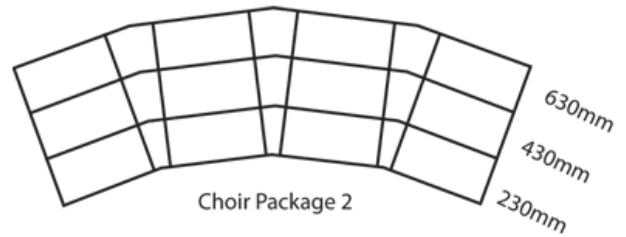

CODE	DESCRIPTION	SIZE IN MM	PRICE
S24SS09048	Carpetted Decks	1000L x 520W	£3985.00
S24SS09049	Vinyl Decks	1000L x 520W	£4184.10
S24SS09050	Heavy Duty Vinyl Decks	1000L x 520W	£4437.85

- Tested to 1000kg per metre squared even load
- Point load testing to 180kg
- A 5mm Allen key is supplied for assembly

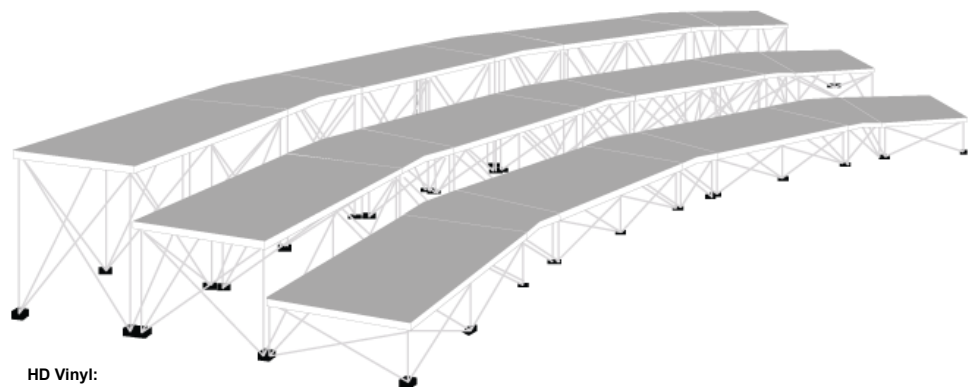

Carpet colours:



Vinyl:



HD Vinyl:



5 Choir Package 3

This Ultralight choir package has a clever concertina design and is lightweight yet extremely strong. Choose from carpetted, vinyl or heavy duty vinyl decks.

The package includes:

- 8 x Stage decks & risers 1M x 1M (4 x 430H, 4 x 630H)
- 4 x Stage decks & risers 1M x 0.52M (230H)
- 6 x Choir infill decks and risers 1M (3 x 430H, 3 x 630H)
- 3 x Choir infill decks and risers 0.52M (230H)
- 28 x Riser clamps

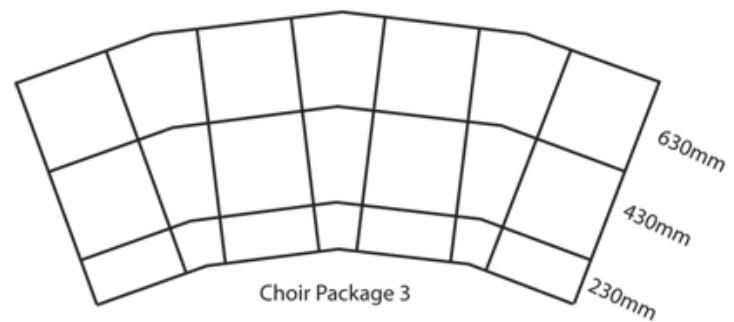

CODE	DESCRIPTION	SIZE IN MM	PRICE
S24SS09051	Carpetted Decks	1000L x 1000W	£5313.35
S24SS09052	Vinyl Decks	1000L x 1000W	£5578.75
S24SS09053	Heavy Duty Vinyl Decks	1000L x 1000W	£5881.30

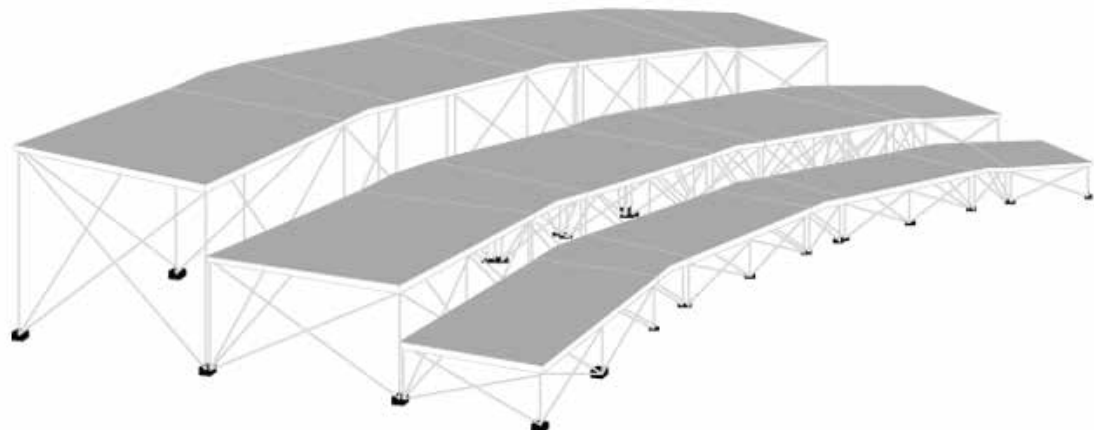

Carpet colours:

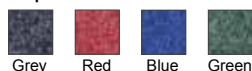

Vinyl:



HD Vinyl:



5 Chair Stop Plates



Supplied with all the fixings you need, the chair stop plate can be easily fitted to the side extrusion of the stage deck, to ensure that chairs do not slip off the edge of the stage. The chair stop plate has been designed so that it can also be used with a guardrail if required.

CODE	DESCRIPTION	WEIGHT	PRICE
S24SS09054	500mm length	0.75kg	£30.00
S24SS09055	1000mm length	1.5kg	£45.00
S24SS09056	2000mm length	3kg	£85.00



Chair Stop Plates

5 Valances



By adding a valance (sometimes known as curtaining or skirting) around the edge of your Ultralight stage, you will not only disguise the aluminium risers but will give your stage a clean and professional look and finish. The fabric used is Fire Retardant in a choice of four colours and is pleated to give fullness.

CODE	DROP	LENGTH	PRICE
S24SS09057	180mm	Per Metre	£48.05
S24SS09058	230mm	Per Metre	£48.05
S24SS09059	330mm	Per Metre	£52.35
S24SS09060	430mm	Per Metre	£57.95
S24SS09061	630mm	Per Metre	£73.45



Valance colours:



5 Riser Accessories

Our range of riser accessories help to secure your staging. The clamps are used when fitting steps or tiered staging, the levellers are used to straighten the stage on uneven floors and the antislip plugs are a simple rubber tool which can be plugged into each foot to prevent slipping.

CODE	DESCRIPTION	PACK SIZE	PRICE
S24SS09062	Riser Clamp	1	£4.80
S24SS09063	Riser Levellers	20	£16.55
S24SS09064	Antislip Plugs	50	£13.25
S24SS09065	5mm Allen Key		£6.25



Riser Leveller



Antislip Plug

Riser Clamp

5 Trolleys

The Ultralight Trolleys have a robust steel frame, swivel brake castors and a safety strap to secure the staging in transit. Simply place your stage decks on the bed of the trolley and the risers into the side bags provided.

CODE	DESCRIPTION	SIZE IN MM	WEIGHT	PRICE
S24SS09066	Small Trolley	745W x 875L	25kg	£363.55
S24SS09067	Large Trolley	745W x 1675L	50kg	£591.10

- Small trolley holds:
10 x 1m x 1m stage decks and risers
or 20 x 1M x 0.52M stage decks and risers
- Large trolley holds:
10 x 2m x 1m stage decks and risers
or 20 x 1m x 1m stage decks and risers



Small Trolley



Large Trolley



5 Guardrails



If your Ultralight stage is over 600mm high, we recommend that you purchase an optional guardrail to ensure safety for your performers. Made from strong grey powder coated steel the guardrail is secured with the fixing brackets.

CODE	DESCRIPTION	WEIGHT	PRICE
S24SS09068	1000mm Guardrail	7.75kg	£100.00
S24SS09069	2000mm Guardrail	11kg	£150.00
S24SS09070	2 Step Guardrail	7.5kg	£110.00
S24SS09071	3 Step Guardrail	10kg	£120.00
S24SS09072	Small 2 Step Guardrail	5.5kg	£110.00
S24SS09073	Small 3 Step Guardrail	8kg	£120.00
S24SS09074	Straight Bracket		£50.00
S24SS09075	Corner Bracket		£80.00

- Certified to GS TUV DIN15921:2015-09 for load bearing, stability, design and structure
- 2 straight brackets are required per rail
- The step guardrail is for use with 0.52M steps
- The small step guardrail is for use with 0.25M steps



Small 2 Step Guardrail



Small 3 Step Guardrail



Straight Bracket



Corner Bracket

5 One Step Units

The One Step unit is used for the 430mm high staging and is available with a choice of Carpetted, Vinyl or Heavy Duty Vinyl decking:

The package includes:

- 1 x Stage deck 0.25M X 1M
- 1 x Stage deck riser 0.25 X 1M (200mm high)
- 2 x Riser clamps

CODE	DESCRIPTION	SIZE IN MM	PRICE
S24SS09076	One Step Unit Carpetted	1000L x 250W x 230H	£196.65
S24SS09077	One Step Unit Vinyl	1000L x 250W x 230H	£203.10
S24SS09078	One Step Unit Heavy Duty Vinyl	1000L x 250W x 230H	£208.30

- Tested to 1000kg per metre squared even load
- Point load testing to 180kg



Carpet colours:

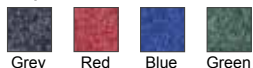

Vinyl:



HD Vinyl:



5 Two Step Units

The Two Step unit is used for the 630mm high staging and is available with a choice of Carpetted, Vinyl or Heavy Duty Vinyl decking:

The package includes:

- 2 x Stage deck 0.25M X 1M
- 1 x Stage deck riser 0.25 X 1M (200mm high)
- 1 x Stage deck riser 0.25 X 1M (400mm high)
- 4 x Riser clamps

CODE	DESCRIPTION	SIZE IN MM	PRICE
S24SS09079	Two Step Unit Carpetted	1000L x 250W x 230-430H	£361.05
S24SS09080	Two Step Unit Vinyl	1000L x 250W x 230-430H	£367.50
S24SS09081	Two Step Unit Heavy Duty Vinyl	1000L x 250W x 230-430H	£376.80

- Tested to 1000kg per metre squared even load
- Point load testing to 180kg



Carpet colours:

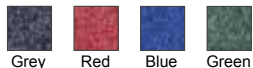

Vinyl:



HD Vinyl:





FORMBASE FURNITURE 2024



FORMBASE FURNITURE

EDUCATIONAL FURNITURE CATALOGUE 2024

www.formbasefurniture.co.uk

sales@formbasefurniture.co.uk

50 Elmfield Road, Chingford, London E4 7HU

Phone: 020 8524 2162